



topcoilsite.com

HEAVY LIFT 25 TON ROD HOOK Operators Manual



554-578-600
25 Ton Snap-In Short Hook

Content	Page
Trico Customers.....	2
Assembly Drawing.....	3
Critical Area Drawing.....	4
Operation.....	5
Maintenance.....	6

Document: M3
Revision: A
Printed: August 2018
Author: Jordan Simpson

Thank-you for choosing Trico. We at Topco Oilsite Products design and build Trico equipment with you, the customer in mind.

To help ensure trouble-free operation of your equipment, read this manual carefully and follow its recommendations.

An authorized Topco facility knows your equipment best. So when maintenance or service is necessary, that's the place to go.



General Cautions and Warnings

Maximum working load indicates the greatest force or load a product can carry under usual environmental conditions. Shock loading and extraordinary conditions will reduce the maximum working load rating. The maximum working load rating may also be affected by wear, misuse, overloading, corrosion, deformation, intentional alteration, and other use conditions.

Regular inspection shall be conducted to determine whether use can be continued at the maximum working load rating, a reduced maximum working load rating, or whether the product shall be withdrawn from service.

Important Notes About This Manual

All specifications and descriptions are accurate at the time of printing. Because continuous improvement is a goal at Topco, we reserve the right to make changes in specifications at any time without notice and without obligation.

Please be aware that this manual applies to all models, equipment, and options. As a result, you may find some explanations not applicable to your equipment.





Quality

If you have any questions, concerns, or feedback regarding the quality of our products and services please contact us.

Safety

Ensure equipment is operated in accordance with all government, regulatory and employer requirements.

Markings

-  This symbol means "Do not let this happen."
-  This symbol means a minimum operating temperature of -20°C (-4°F).
-  This symbol means a minimum operating temperature of -46°C (50°F).
-  This symbol means failure to comply may result in damage or injury.

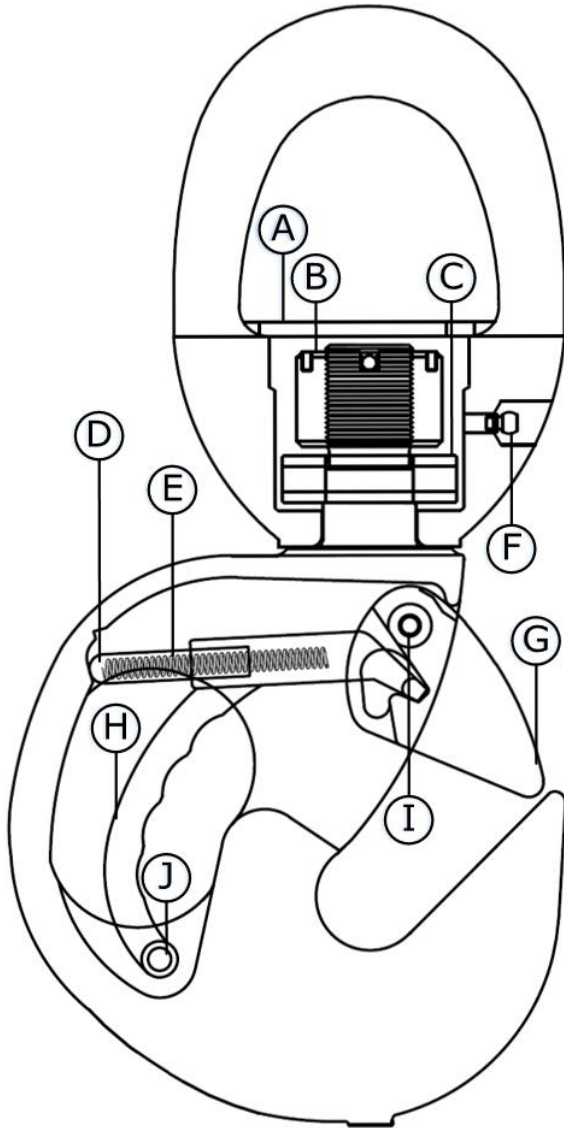

A. Grease Cap

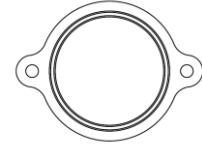

554-542-500

Grease Cap Gasket

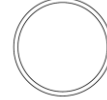

554-542-500G

2x Grease Cap Screw



554-542-600

B. Nut & Pin

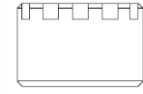

554-542-901

C. Bearing

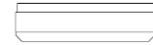

554-543-400

D. Spring Housing

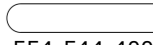

554-544-400

E. Spring



554-544-700

F. Grease Zerk



554-578-700

G. Latch



554-544-400

H. Lever

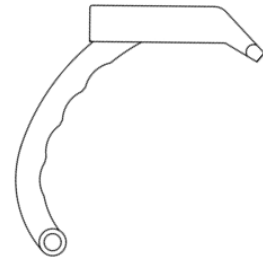

554-544-200

I. Latch Pin

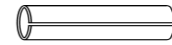

554-543-105

J. Lever Pin

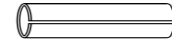

554-543-100

Wear Limits		Critical Area
Hook Seat	Clevis Seat	
Minimum 71 mm (2.80 in)	Minimum 38 mm (1.48 in)	

Body

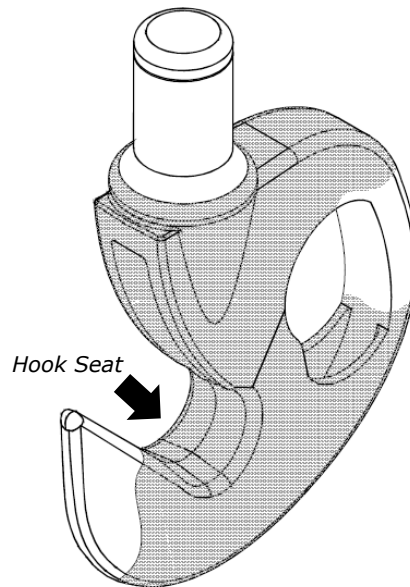

Bail

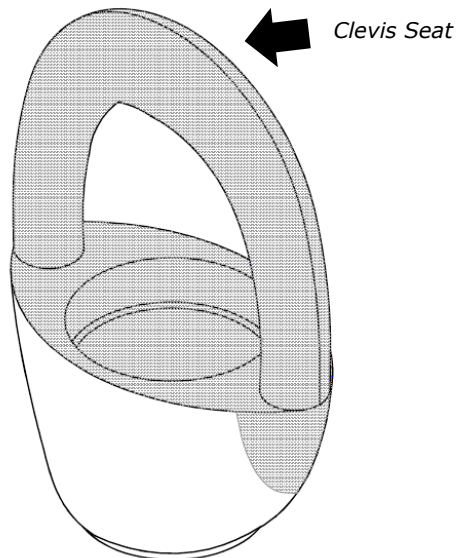



WARNING: Failure to follow these directions could result in damage or injury.

- ▶ Trico Rod Hooks are designed to support Trico Rod Elevators. Never use them for any other purpose.
- ▶ Trico Rod Hooks use a snap-in style latching mechanism. Never use them in a manner that may cause the latch to dis-engage.
- ▶ Only lift Hooks in a vertical direction using the clevis seat.
- ▶ Never exceed the maximum working load of the Hook.
- ▶ Do not operate without grease or if the bearing is damaged.
- ▶ Never operate below the minimum operating temperature.

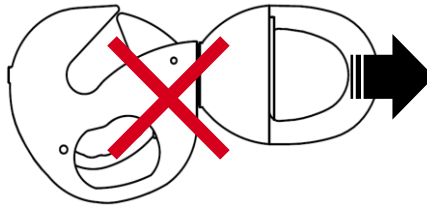

Heavy Lift New Equipment Specifications

- ▶ Maximum Working Load: 25 short tons (50,000 lbs).
- ▶ Minimum Operating Temperature: -46°C (-50°F).

Before Each Use

- ▶ Ensure the bail freely rotates in both directions, and is tightly secured to the body.
- ▶ Ensure the bearing is lubricated for every 8 hours of operation using a NLGI certified grease meeting GC-LB standards.

Inserting and Removing Elevators

- ▶ Engage the lever (A) to insert and remove an Elevator (B).

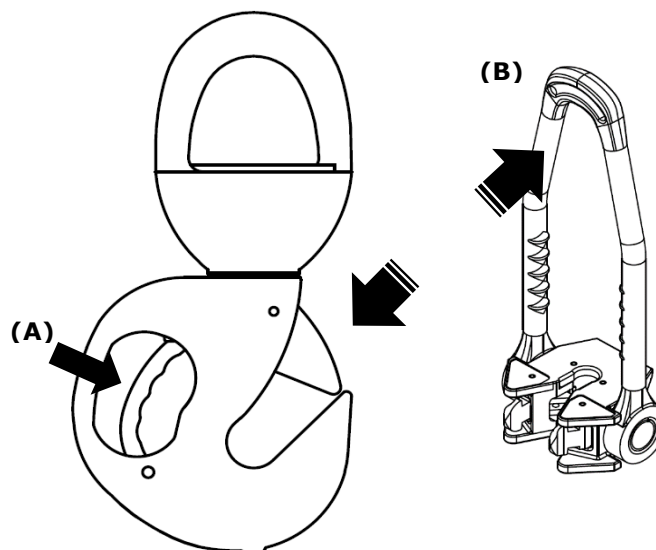



WARNING: Failure to follow these directions could result in damage or injury.

- ▶ Never weld, grind, or modify in any way.
- ▶ Only use Trico Original Equipment Manufacturer (“OEM”) replacement parts.
- ▶ Never operate a hook with a Non-OEM bearing.
- ▶ Never install a nut without a pin.



Recommended Maintenance Practice

API Recommended Practice 8B and CAODC Recommended Practice 4.0 are approved for the maintenance of Trico Rod Hooks. At a minimum, it is recommended that all Category/Level III and IV maintenance be conducted at an authorized Trico inspection facility.

Recommended Maintenance Schedule

This schedule is a guide only. The equipment owner/operator should consider the following factors when building a maintenance schedule; environment, load cycles and operating time.

Category	Level	Type	Frequency		Method	Corrective Action
			API	CAODC		
I		Visual	1 day (Daily)	1 day (Daily)	<ul style="list-style-type: none"> • Observation during operation 	Contact Topco to locate an authorized Trico inspection facility.
II		Visual	7 days (Weekly)	7 days (Weekly)	<ul style="list-style-type: none"> • Cracks • Loose connections • Yielding • Wear • Corrosion 	
III		Physical	6 months (Bi-annually)	1 year (Annually)	<ul style="list-style-type: none"> • NDT of critical areas • Wear limits 	
IV		Disassembly	1 year (Annually)	6 years	<ul style="list-style-type: none"> • Inspection at an authorized Trico facility 	

Contact Information



TOPCO OILSITE PRODUCTS LTD.

Toll free: 1 800 222 6448
 Edmonton: 780 436 3400
 ContactUs@TopcoOilsite.com
 TopcoOilsite.com

